



www.cougargaming.com

UNIFACE 影武者 X5 PRO

FEATURES

特点, 特點

P 4-5

ASSEMBLY DRAWING

爆炸图, 爆炸圖

P 6-9

SPECIFICATIONS

规格, 規格

P 10-11

I/O CONNECTORS

I/O线材接头, I/O線材接頭

P 12

ACCESSORY KIT

配件包, 配件包

P 13

REMOVING PANELS

前面板与侧板拆卸说明, 前面板與側板拆卸說明

P 14-15

INSTALLING WATER COOLING RADIATORS & COOLING FANS

水冷与风扇安装说明, 水冷與風扇安裝說明

P 16-17

INSTALLING VERTICAL GRAPHIC CARD

显卡垂直安装说明, 顯卡垂直安裝說明

P 18-21

INSTALLING THE 3.5" HDDS

3.5" HDDS 安装说明, 3.5" HDDS 安裝說明

P 22-23

INSTALLING THE 2.5" SSDS

2.5" SSDS 安装说明, 2.5" SSDS 安裝說明

P 24-25

GLOBAL WARRANTY POLICY

全球保固条款, 全球保固條款

P 26-27

FEATURES

特点, 特點

ENGLISH

- Keep components safe with reliability you can depend on.
- Choice of 420mm front panel or 360mm top panel water cooling support.
- Accommodates maximum GPU length of 400mm.
- Supports 2x 120mm fans (motherboard side) to enhance ventilation and airflow.

ESPAÑOL

- Mantenga los componentes seguros con una confiabilidad en la que puede confiar.
- Opción de soporte de refrigeración por agua para panel frontal de 420 mm o panel superior de 360 mm.
- Admite una longitud máxima de GPU de 400 mm.
- Admite 2 ventiladores de 120 mm (lado de la placa base) para mejorar la ventilación y el flujo de aire.

PORTUGUÊS

- Mantenha os componentes seguros com a confiabilidade na qual você pode confiar.
- Escolha entre o painel frontal de 420 mm ou o suporte refrigerado por água de 360 mm.
- Acomoda comprimento máximo de GPU de 400 mm.
- Suporta 2 ventoinhas de 120 mm (lado da placa-mãe) para melhorar a ventilação e o fluxo de ar.

FRENCH

- Protégez vos composants avec une fiabilité sur laquelle vous pouvez compter.
- Choix de support de refroidissement par eau pour panneau avant de 420 mm ou panneau supérieur de 360 mm.
- Accepte une longueur maximale de GPU de 400 mm.
- Prend en charge 2 ventilateurs de 120 mm (côté carte mère) pour améliorer la ventilation et le flux d'air.

RUSSIAN

- Обеспечьте безопасность компонентов и надежность, на которую вы можете положиться.
- Возможность выбора между 420 мм передней панелью или 360 мм верхней панелью с водяным охлаждением.
- Вмещает максимальную длину графического процессора 400 мм.
- Поддерживает 2 вентилятора диаметром 120 мм (со стороны материнской платы) для улучшения вентиляции и воздушного потока.

DEUTSCH

- Schützen Sie Ihre Komponenten mit Zuverlässigkeit, auf die Sie sich verlassen können.
- Wahlweise 420-mm-Frontplatten- oder 360-mm-Oberplatten-Wasserkühlungshalterung.
- Bietet Platz für eine maximale GPU-Länge von 400 mm.
- Unterstützt 2x 120-mm-Lüfter (Motherboard-Seite) zur Verbesserung der Belüftung und des Luftstroms.

日本語

- 信頼できる信頼性でコンポーネントを安全に保ちます。
- 420mm フロント パネルまたは 360mm トップ パネルの水冷サポートを選択できます。
- 最大 GPU 長さ 400mm に対応します。
- 2x 120mm ファン (マザーボード側) をサポートし、換気とエアフローを強化します。

繁 中

- 確保您的核心硬體設備安全可靠
- 支援前板420mm 或上蓋 360mm水冷排
- 最高支援 400mm 顯卡
- 主板右側支援兩個 120mm 風扇 · 可提升散熱氣流

KOREAN

- 신뢰할 수 있는 신뢰성으로 구성요소를 안전하게 유지하세요.
- 420mm 전면 패널 또는 360mm 상단 패널 수냉식 지원 중에서 선택하세요.
- 최대 GPU 길이 400mm를 수용합니다.
- 환기 및 공기 흐름을 향상시키기 위해 2개의 120mm 팬(마더보드 측)을 지원합니다.

簡 中

- 確保您的核心硬體設備安全可靠
- 支持前板420mm 或上蓋 360mm水冷排
- 最高支持400mm 顯卡
- 主板右側支持兩個 120mm 風扇 · 可提升散熱氣流

ASSEMBLY DRAWING

爆炸图, 爆炸圖

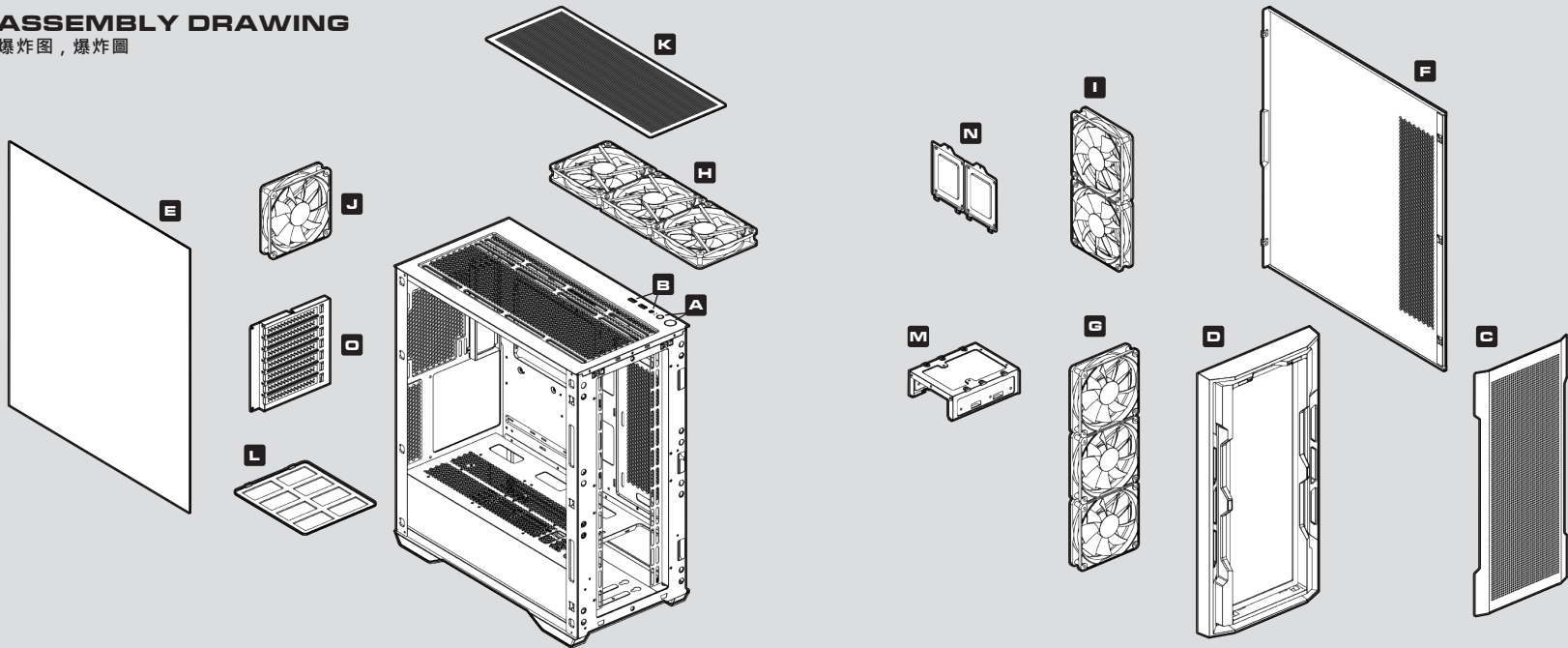

ASSEMBLY DRAWING

爆炸图，爆炸圖

- A** Power button / Reset button
电源键 / 重启键
電源鍵 / 重啟鍵
- B** USB 3.0 / 4 Pole Headset Audio Jack
USB 3.0 / 四极音效孔
USB 3.0 / 四極音效孔
- C** Airflow front panel
金属网孔前饰板
金屬網孔前飾板
- D** Front panel
前面板
前面板
- E** Tempered glass side panel
玻璃左侧板
玻璃左側板
- F** Metal side panel
金属右侧板
金屬右側板
- G** 3 x 120mm / 3 x 140mm fans for front panel
前板支援3 x 120mm / 3 x 140mm 風扇
前板支援3 x 120mm / 3 x 140mm 風扇
- H** 3 x 120mm / 2 x 140mm fans for top panel
上盖支援3 x 120mm / 2 x 140mm 風扇
上蓋支援3 x 120mm / 2 x 140mm 風扇
- I** 2 x 120mm for M/B side
右侧支援2 x 120mm 風扇
右側支援2 x 120mm 風扇
- J** 1 x 120mm / 1 x 140mm fan for rear panel
背板支援1 x 120mm / 1 x 140mm風扇
背板支援1 x 120mm / 1 x 140mm風扇
- K** Top dust filter
上盖防尘滤网
上蓋防塵濾網
- L** Bottom dust filter
底板防尘滤网
底板防塵濾網
- M** 3.5" HDD tray (compatible for 2.5" SSD)
3.5" HDD托盘 (可转换为2.5" SSD托盘)
3.5" HDD托盤 (可轉換為2.5" SSD托盤)
- N** 2.5" SSD tray
2.5" SSD托盘
2.5" SSD托盤
- O** Expansion slots (Horizontal slots can be converted into vertical slots.)
扩充槽挡板 (水平扩充槽可转换为垂直扩充槽)
擴充槽檔板 (水平擴充槽可轉換為垂直擴充槽)

SPECIFICATIONS

规格, 规格

Product Name 产品名称, 產品名稱	UNIFACE 影武者 X5 PRO
Case Form Factor 机箱规格, 機箱規格	Mid Tower 中塔机箱, 中塔機箱
Motherboard Type 主板类型, 主板類型	Mini ITX / Micro ATX / ATX / CEB / E-ATX
Dimension 尺寸 (宽x高x深), 尺寸 (寬 x 高 x 深)	230 x 493 x 475 (mm) / 9.1 x 19.4 x 18.7 (in)
I/O Panel I/O 接口, I/O接口	USB 3.0 x 2, 4 Pole Headset Audio Jack x 1, Reset Button USB 3.0 x 2, 四极音效孔 x 1, 重啟键 USB 3.0 x 2, 四極音效孔 x 1, 重啟鍵
3.5" Drive Bay 3.5" 硬盘槽, 3.5" 硬碟槽	2
2.5" Drive Bay 2.5" 硬盘槽, 2.5" 硬碟槽	2+1 (converted from 3.5" drive bays) 2+1 (3.5" 硬盘槽可转换为2.5"硬盘槽) 2+1 (3.5" 硬碟槽可轉換為2.5"硬碟槽)
Expansion Slots 扩充插槽, 擴充插槽	7 (horizontal slots can be converted into vertical slots) 7 (水平扩充槽可转换为垂直扩充槽) 7 (水平擴充槽可轉換為垂直擴充槽)
Vertical GPU Support 支援显卡垂直安装, 支援顯卡垂直安裝	Yes

Cooling Fan Support 散热风扇规格, 散熱風扇規格	Front (前板, 前板): 120mm x 3 / 140mm x 3
	Top (上盖, 上蓋): 120mm x 3 / 140mm x 2
	M / B side (右侧, 右側): 120mm x 2
	Rear (背板, 背板): 120mm x 1 / 140mm x 1
Maximum Number of Fans 最高风扇安装数量, 最高風扇安裝數量	9
Water Cooling Radiator Support 水冷排规格, 水冷排規格	Front (前板, 前板): 420mm / 360mm / 280mm / 240mm / 140mm / 120mm
	Top (上盖, 上蓋): 360mm / 280mm / 240mm / 140mm / 120mm
	M / B side (右侧, 右側): 240mm / 120mm
	Rear (背板, 背板): 140mm / 120mm
Transparent Left Panel 透明左侧盖, 透明左側蓋	Yes
Max. Graphics Card Length 显卡最大长度, 顯卡最大長度	400 (mm) / 15.7 (in)
Max. CPU Cooler Height CPU 风扇最大高度, CPU 風扇最大高度	180 (mm) / 7.1 (in)
Max. PSU Length 电源供应器最大长度, 電源供應器最大長度	210 (mm) / 8.3 (in)

• Please choose to install either an E-ATX motherboard or a radiator / fan on the M/B side.

• Please choose to install either a radiator on the M/B side or front panel.

• 请在择一安装E-ATX主板或是右侧水冷排/风扇
• 请在右侧或前板择一安装水冷排

• 請在擇一安裝E-ATX主板或是右側水冷排/風扇
• 請在右側或前板擇一安裝水冷排





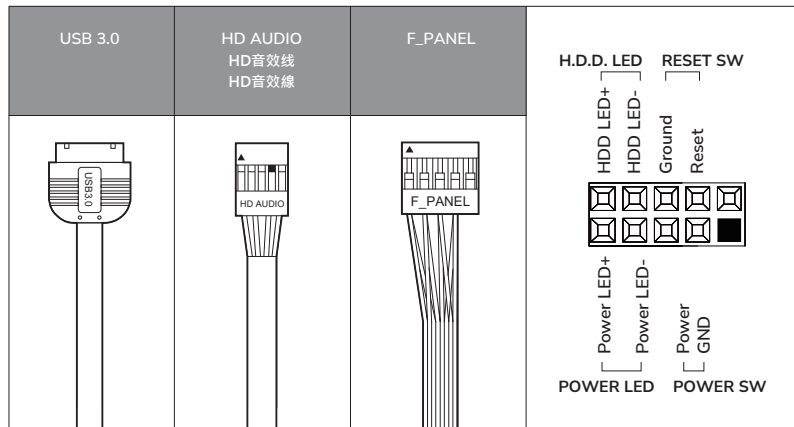



INSTALLING THE I / O CONNECTORS

I/O线材接头, I/O線材接頭



ACCESSORY KIT

配件包, 配件包

<p>1 </p> <p>3.5" HDD screws 3.5" HDD螺絲, 3.5" HDD螺絲</p> <p>X 8</p>	<p>5 </p> <p>Stand-off for motherboard 主機板銅柱, 主機板銅柱</p> <p>X 3</p>
<p>2 </p> <p>Motherboard screws & 2.5" SSD screws 主機板螺絲 & 2.5" SSD螺絲 主機板螺絲 & 2.5" SSD螺絲</p> <p>X 23</p>	<p>6 </p> <p>Stand-off socket attachment 銅柱套筒, 銅柱套筒</p> <p>X 1</p>
<p>3 </p> <p>Stand-off for VGA riser cable 垂直顯卡排線銅柱, 垂直顯卡排線銅柱</p> <p>X 2</p>	<p>7 </p> <p>Power supply screws & Graphic card screws 電源螺絲 & 顯卡螺絲, 電源螺絲 & 顯卡螺絲</p> <p>X 8</p>
<p>4 </p> <p>Thumb screws 手動螺絲, 手動螺絲</p> <p>X 2</p>	<p>8 </p> <p>Cable ties 束線帶, 束線帶</p> <p>X 10</p>

REMOVING PANELS

前面板与侧板拆卸说明, 前面板與側板拆卸說明

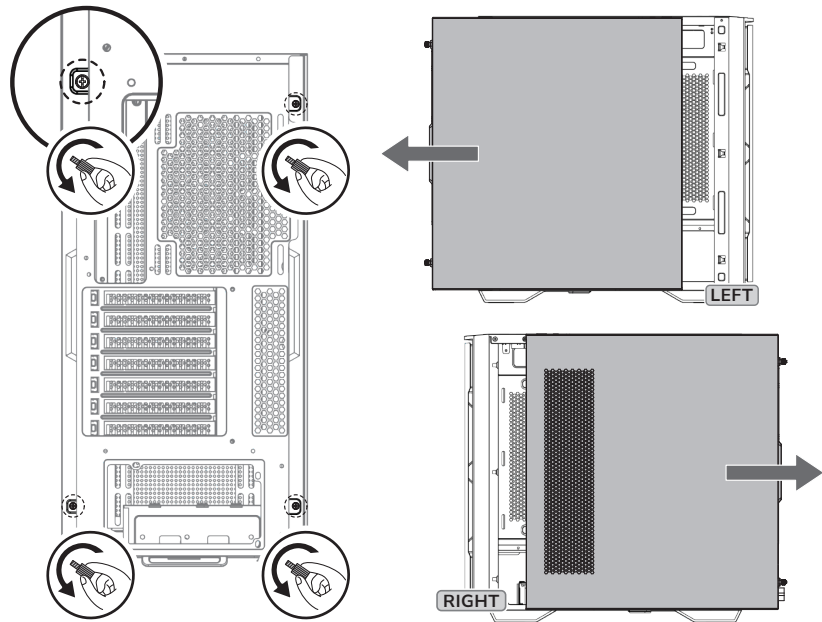
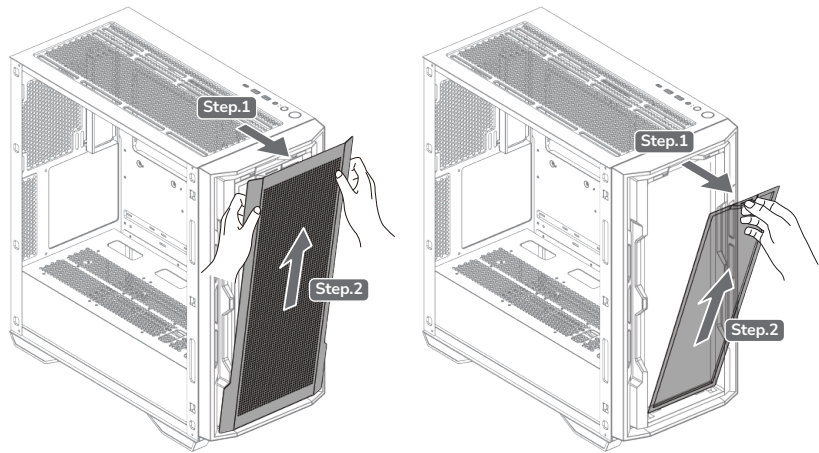

INSTALLING WATER COOLING RADIATORS

水冷安装说明, 水冷安装说明

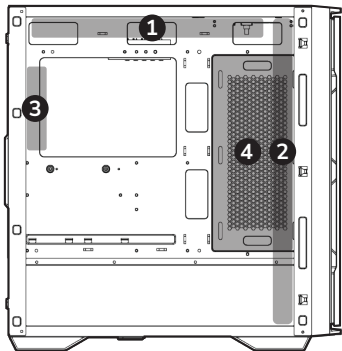

1 Top 上盖, 上盖

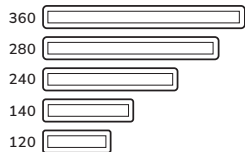

2 Front 前板, 前板

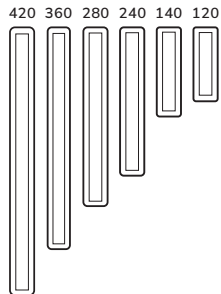

3 Rear 背板, 背板



4 M/B side 右侧, 右侧

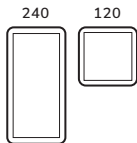

• Please choose to install either an E-ATX motherboard or a radiator/fan on the M/B side.

• Please choose to install either a radiator on the M/B side or front panel.

• 请在择一安装E-ATX主板或是右侧水冷排/风扇

• 请在右侧或前板择一安装水冷排

• 请在择一安装E-ATX主板或是右侧水冷排/风扇

• 请在右侧或前板择一安装水冷排

INSTALLING COOLING FANS

风扇安装说明, 风扇安装说明

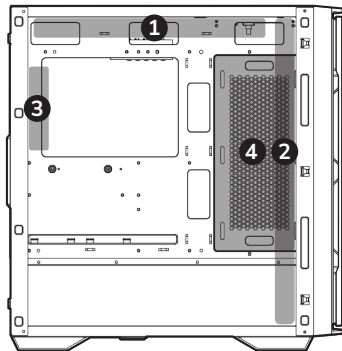

1 Top 上盖, 上盖

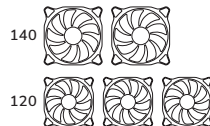

2 Front 前板, 前板



3 Rear 背板, 背板

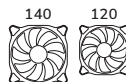

4 M/B side 右侧, 右侧



• Please choose to install either an E-ATX motherboard or a radiator/fan on the M/B side.

• Please choose to install either a radiator on the M/B side or front panel.

• 请在择一安装E-ATX主板或是右侧水冷排/风扇

• 请在右侧或前板择一安装水冷排

• 请在择一安装E-ATX主板或是右侧水冷排/风扇

• 请在右侧或前板择一安装水冷排

INSTALLING VERTICAL GRAPHIC CARD

显卡垂直安装说明, 显卡垂直安装说明

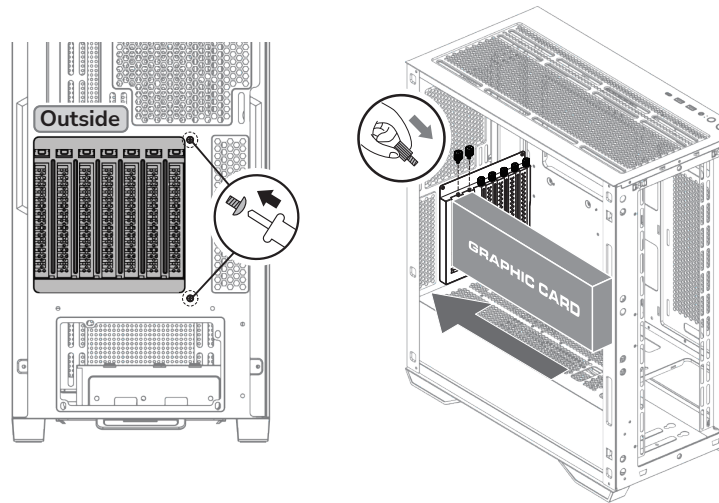
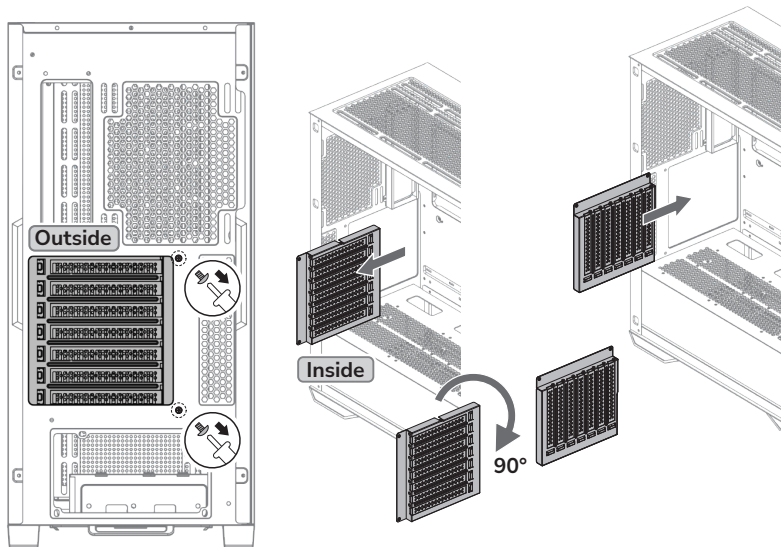

INSTALLING VERTICAL GRAPHIC CARD

显卡垂直安装说明, 显卡垂直安装说明

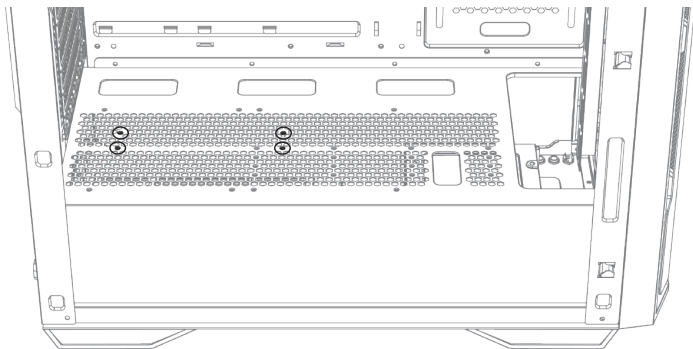

The screw pitch on the PSU shroud is 125mm, please check your PCI-E riser cable, and install the stand-off for the VGA riser cable at the corresponding position.

电源仓盖板的锁孔间距为125mm·请依照您的PCI-E转接线孔距·将垂直显卡排线铜柱锁固在对应位置·
電源倉蓋板的鎖孔間距為125mm·請依照您的PCI-E轉接線孔距·將垂直顯卡排線銅柱鎖固在對應位置·

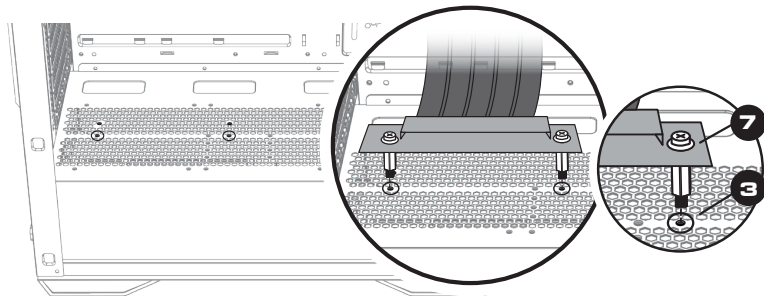

Motherboard screws and 2.5" SSD screws
主機板螺絲 / 2.5" SSD螺絲
主機板螺絲 / 2.5" SSD螺絲



Stand-off for VGA riser cable
垂直显卡排线铜柱
垂直顯卡排線銅柱



The vertical graphic card and the PCI-E riser cable are not included in the package, please purchase separately.

显卡和 PCI-E 转接线不包含在包装内·请单独购买·

顯卡和 PCI-E 轉接線不包含在包裝內·請單獨購買·

INSTALLING THE 3.5" HDDS

3.5" HDD 安装说明, 3.5" HDD 安裝說明

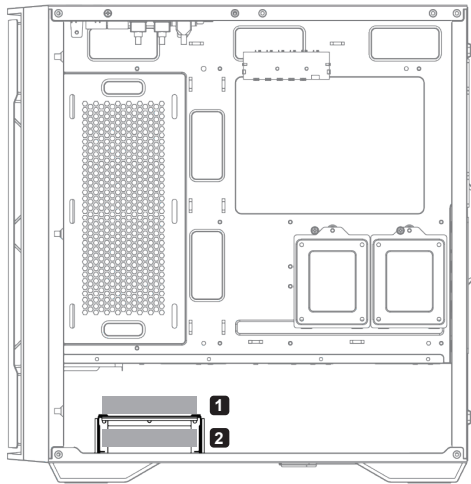

Step.1

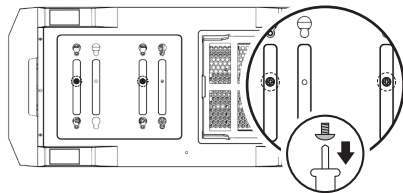

Step.2

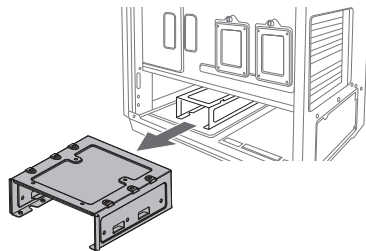

Step.3

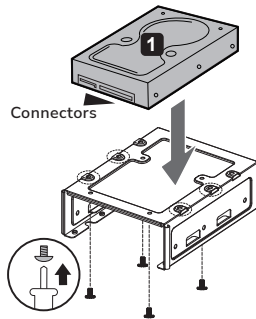

Step.4

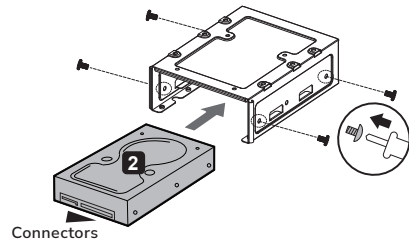

INSTALLING THE 2.5" SSDS

2.5" SSD 安装说明, 2.5" SSD 安裝說明

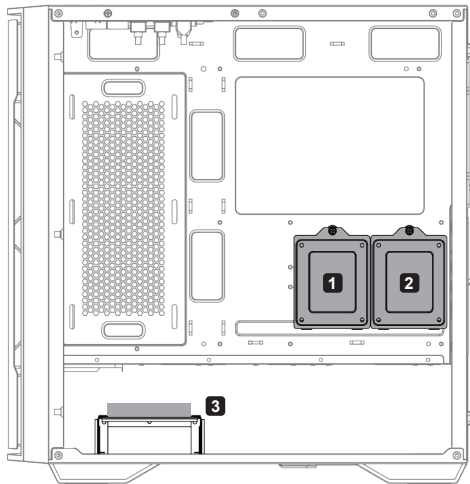

Step.1

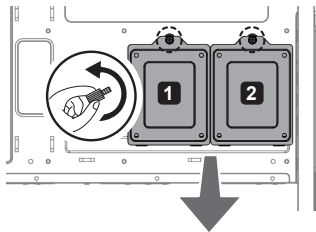

Step.2

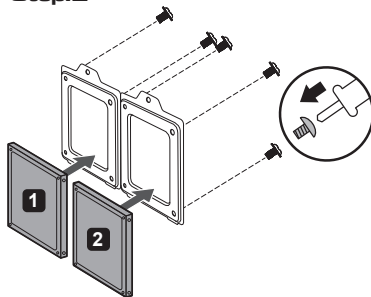

Step.3

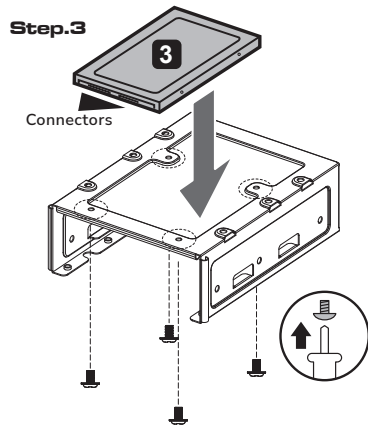

ДАТА ИЗГОТОВЛЕНИЯ ПРОДУКЦИИ

год и месяц изготовления продукции указаны в серийном номере продукта.
(существует 2 способа определения даты изготовления, оба способа описаны ниже)

A После S/N: первые две цифры означают год, вторые две – месяц изготовления.
Например, S/N: **H2310**000001 означает, что товар был произведен в феврале 2023 года.

B После S/N: если указаны буквы, то две буквы представляют цифры из таблицы ниже, и означают год, последующие две цифры – месяц изготовления.

Например, S/N: **DBC10**REVI000001 означает, что товар был произведен в феврале 2023 года.

A	B	C	D	E	F	G	H	I	J
1	2	3	4	5	6	7	8	9	0

• Например,
BC = 23 = 2023 год

تعليمات التركيب و الأمان:

- عند التركيب أو التفكيك يجب التأكد من أن جميع الأسلاك مفصولة عن الكهرباء.

- يجب اتخاذ الاحترازاات اللازمة لمنع الصعق الكهربائي.

- يجب إرتداء الملابس المناسبة أثناء تركيب/ تجميع الكمبيوتر.

- يجب تركيب كل قطعة بحذر و بمكانها المناسب.

- من يقوم بعملية التركيب الشخص المختص فقط.

БЪЛГАРИЯ

• Подробни инструкции за употреба изтеглете от: <https://cougargaming.com/bg>



България QR код

GLOBAL WARRANTY POLICY

全球保固条款, 全球保固條款

WARRANTY PERIODS OF COUGAR GAMING DEVICES

COUGAR 电竞产品保固期, COUGAR 電競產品保固期

Product 产品名称, 產品名稱: COUGAR UNIFACE 影武者 X5 PRO

Warranty 保固期, 保固期: 1 Year 1年, 1年

• This warranty gives you specific legal rights. You may also have other rights granted under local law. These rights may vary.

本保固条款赋予您特定的合法权利, 而您所在的地区可能也会赋予您其他权利。

本保固條款賦予您特定的合法權利, 而您所在的地區可能也會賦予您其他權利。

• Only for electrical components.

仅适用于电子元件, 僅適用於電子元件。



详细保固条款
请扫描二维码



Official website



www.cougargaming.com

COUGAR USA Technical Service

Tel: (833) 256-3778

Mail: rma@compucaseusa.com

Compucase Enterprise Co., Ltd.

All rights reserved.



Made in China